

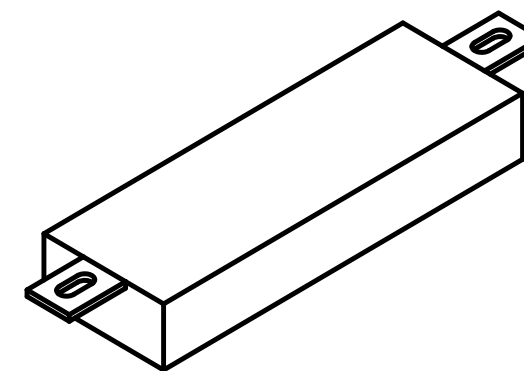

Blockanoden

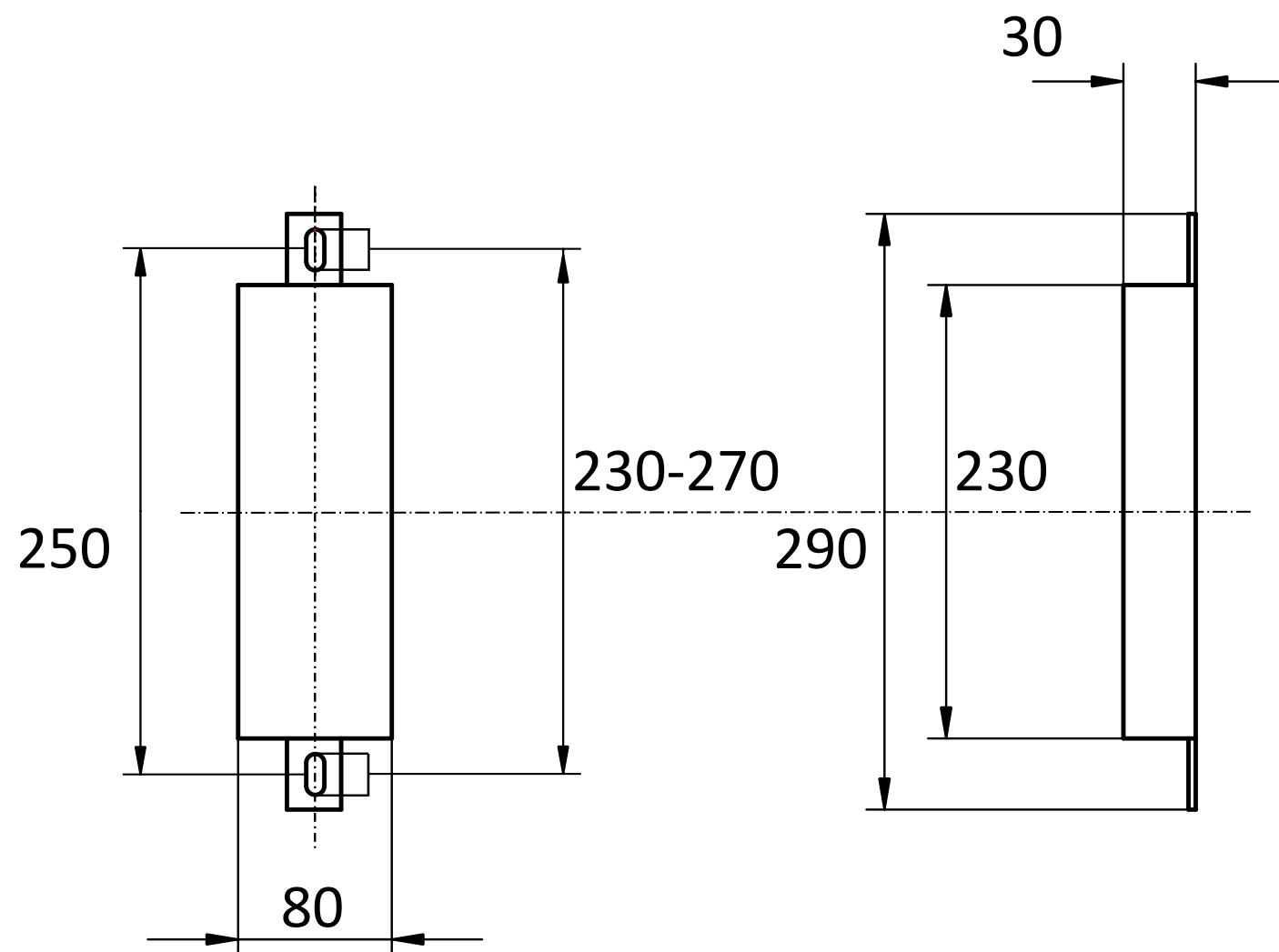

Gekippte-Ansicht

	Anoden Kategorie :	Artikelnummer:			
	Blockanoden	9307			
	Werkstoff:	Gewicht:			
	Zink	3,5kg			
ISO 	Nur zur Information, unterliegt nicht dem Änderungsdienst		Maßstab:		
			/	Zst:	Änderung: Datum: