

Anoden kompatibel zu Mercury

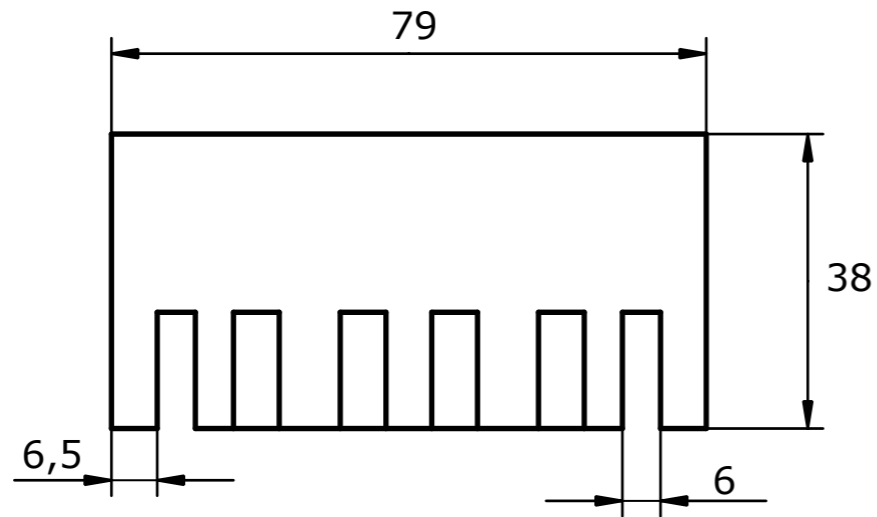

Referenznummer
821631

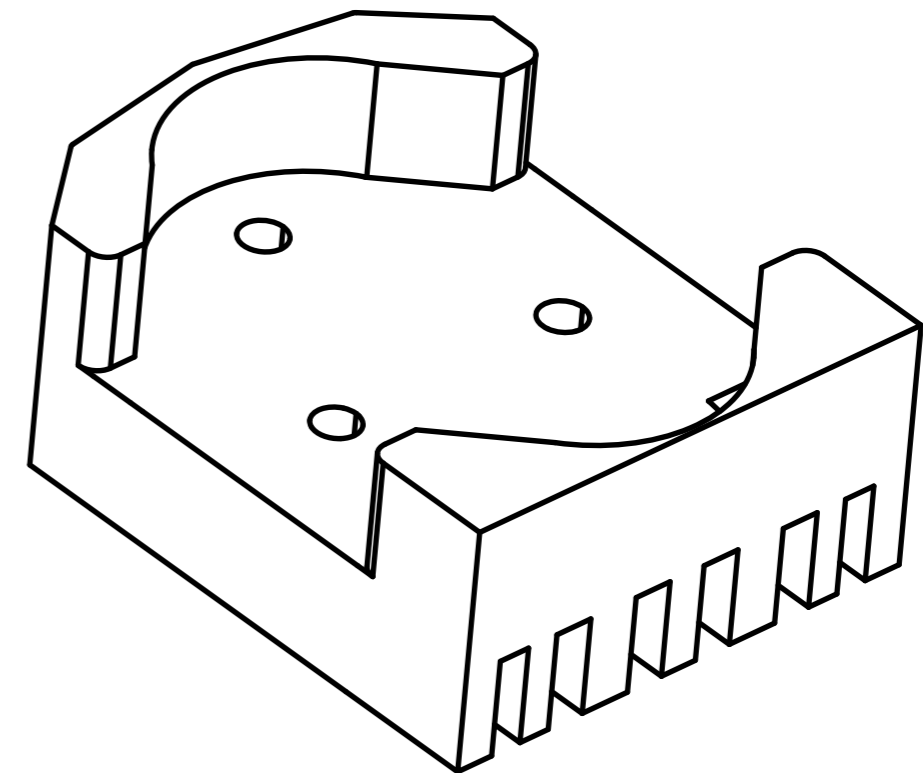
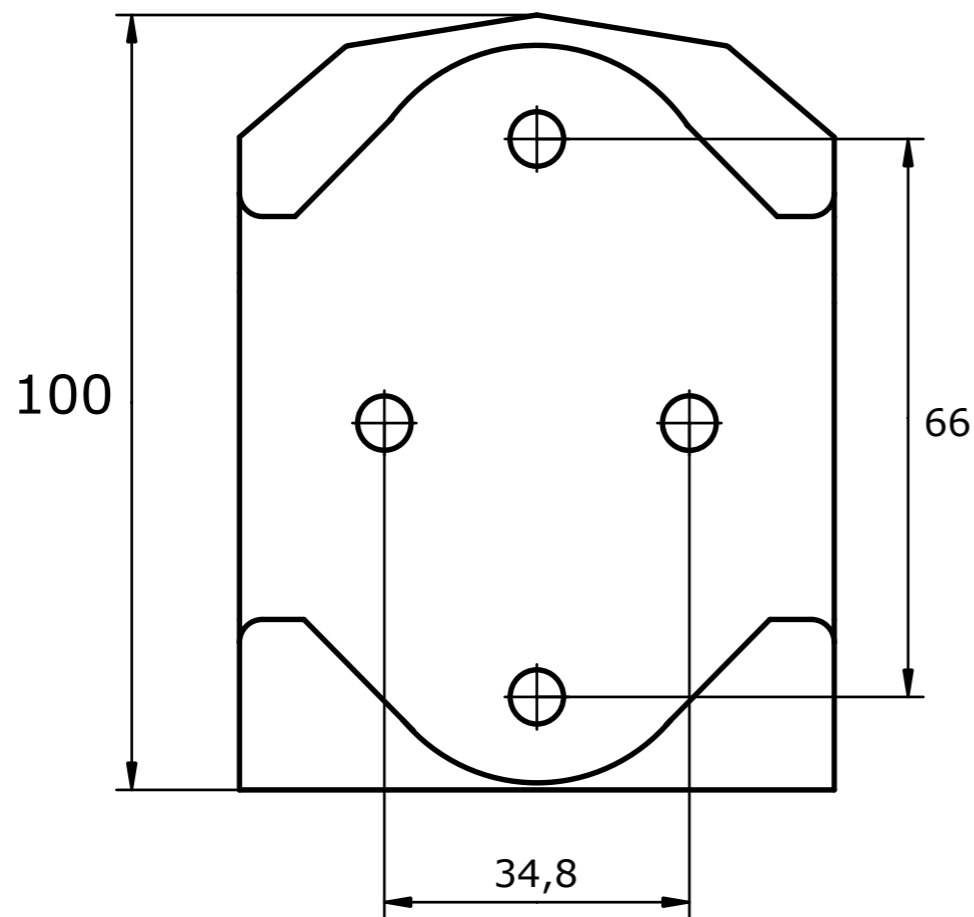

Gekippte-Ansicht

	Anoden Kategorie :	Artikelnummer:			
	Anoden kompatibel zu Mercury	9712AL			
	Werkstoff:	Gewicht:			
	AlZn5In	0,37kg			
ISO	Nur zur Information, unterliegt nicht dem Änderungsdienst		Maßstab: 1:1	Zst:	Änderung: Datum: