

Anoden kompatibel zu Volvo Penta

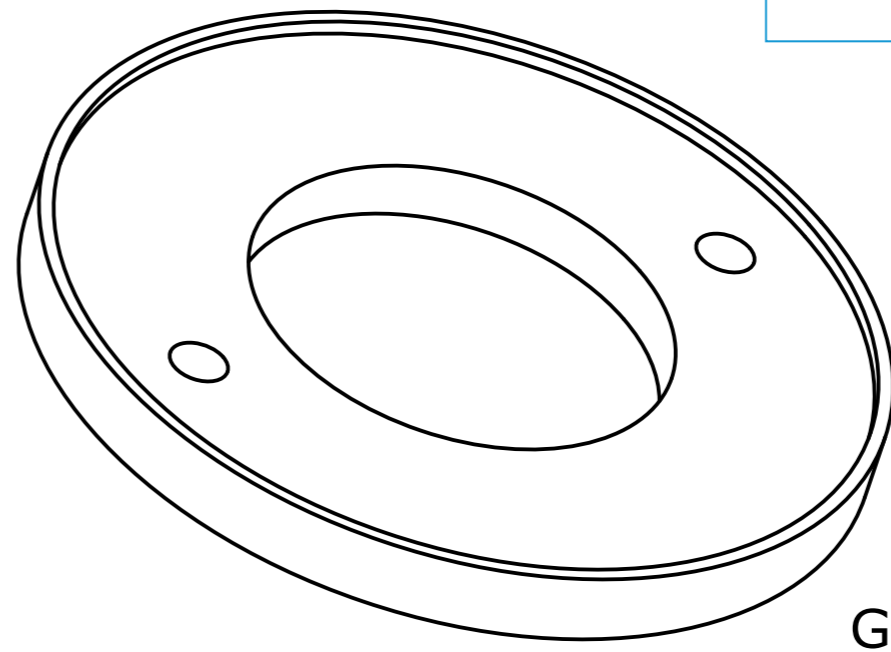
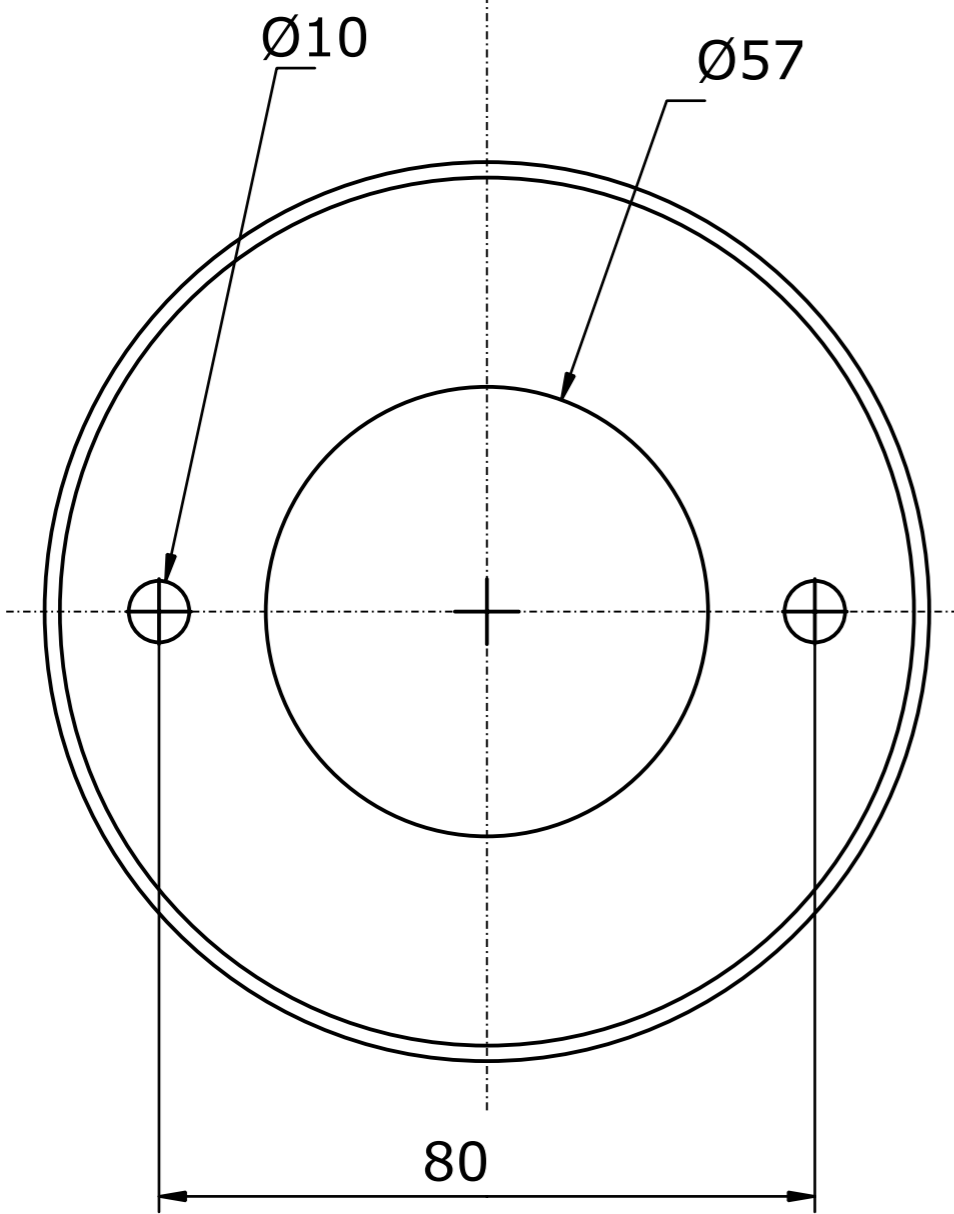
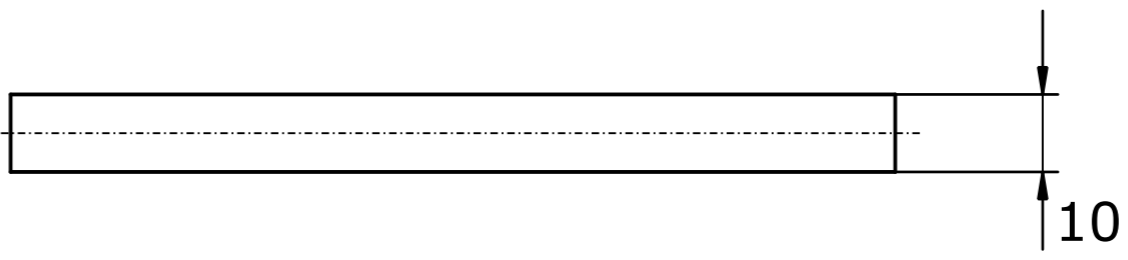
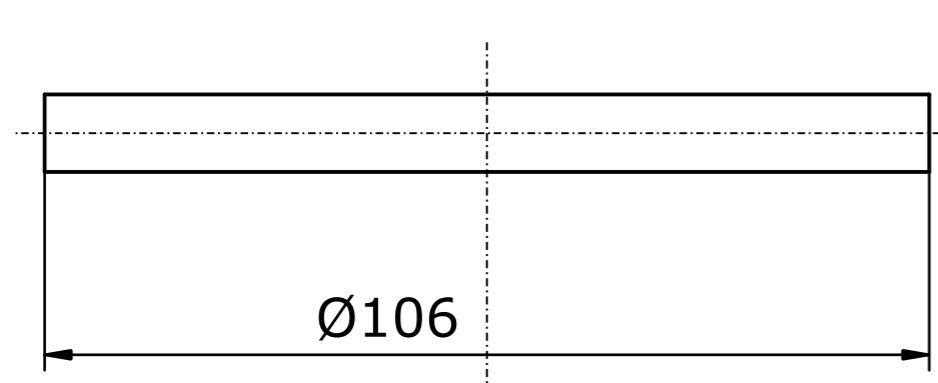

Referenznummer
875809

	Anoden Kategorie :	Artikelnummer:			
	Anoden kompatibel zu Volvo Penta	9211AL			
	Werkstoff:	Gewicht:			
	AlZn5In	0,079kg			
ISO	Nur zur Information, unterliegt nicht dem Änderungsdienst		Maßstab: 1:1	Zst:	Änderung: Datum: