

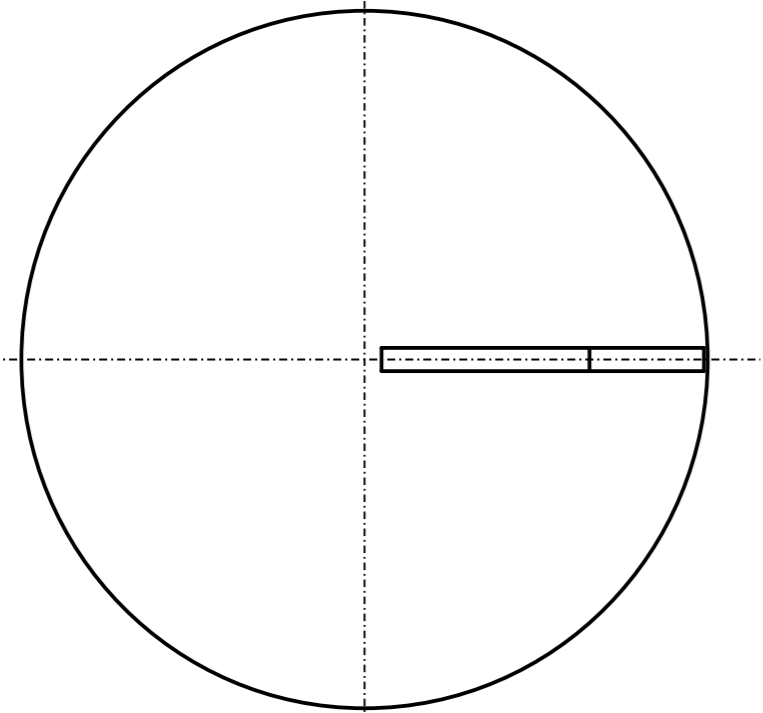

Anoden kompatibel zu Mercury

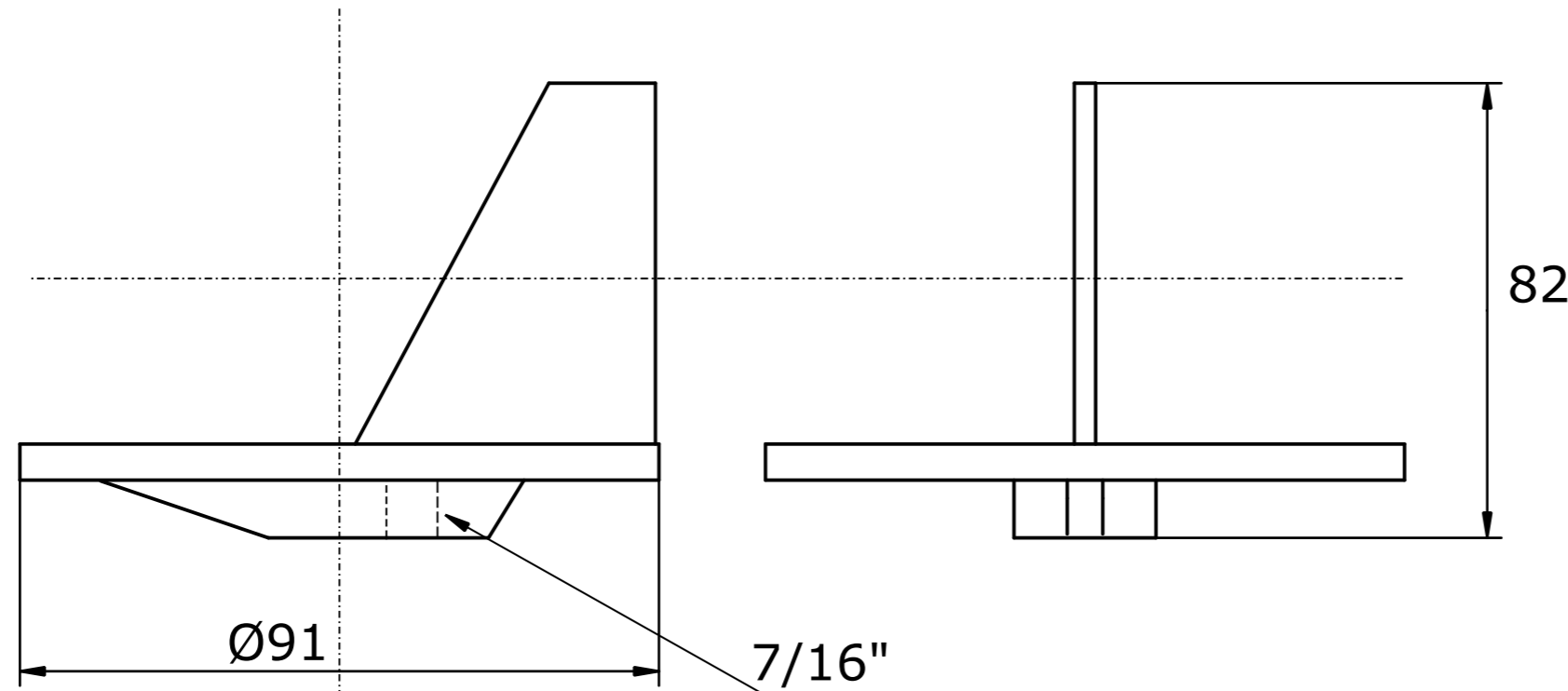

Referenznummer
46399

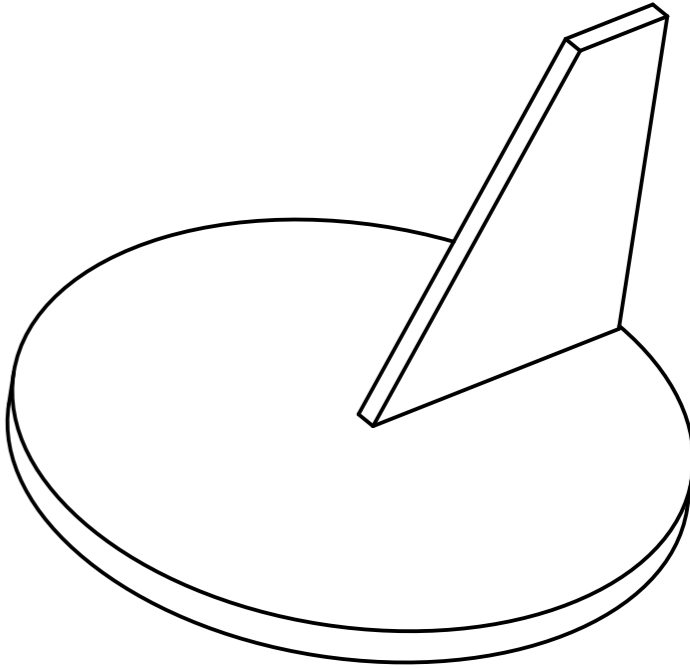

Gekippte-Ansicht

	Anoden Kategorie :	Artikelnummer:			
	Anoden kompatibel zu Mercury	9707AL			
	Werkstoff:	Gewicht:			
	AlZn5In	0,150kg			
ISO	Nur zur Information, unterliegt nicht dem Änderungsdienst		Maßstab: 1:1	Zst:	Änderung: Datum: