

Anoden kompatibel zu Volvo Penta

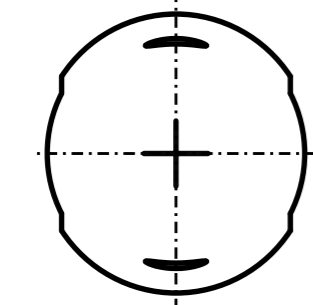

Referenznummer

8333911

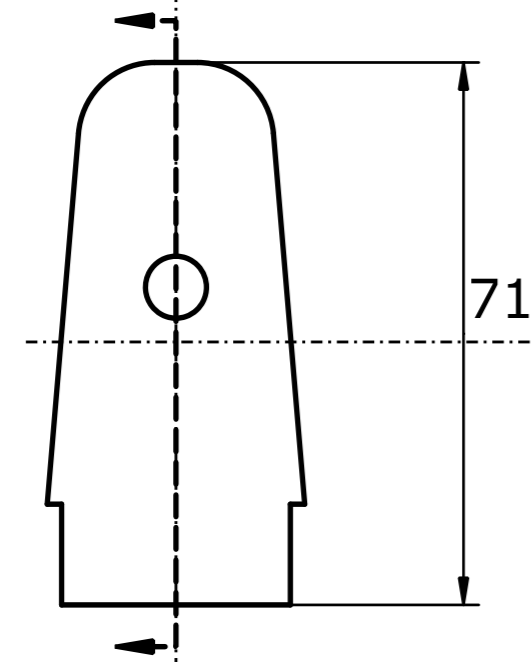
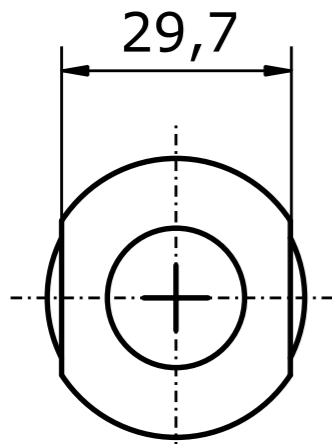
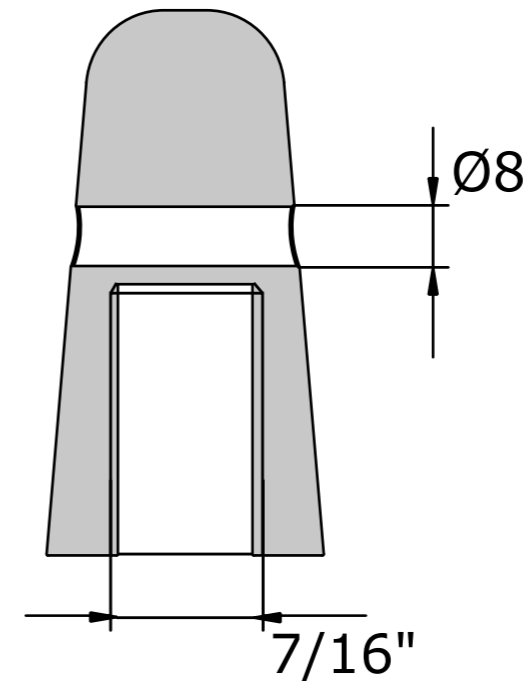

Schnittansicht A-A

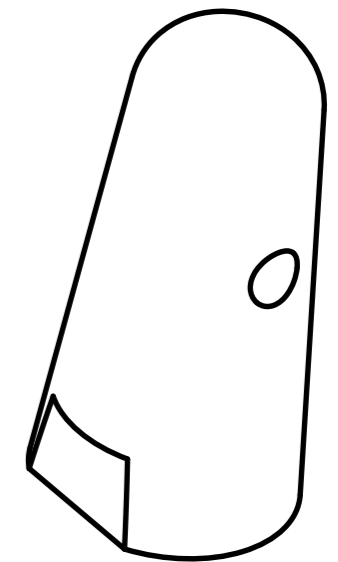

Gekippte-Ansicht

	Anoden Kategorie : Anoden kompatibel zu Volvo Penta	Artikelnummer: 9217AL			
	Werkstoff: AlZn5In	Gewicht: 0,112kg			
ISO	Nur zur Information, unterliegt nicht dem Änderungsdienst		Maßstab: 1:1	Zst:	Änderung: Datum: