

Anoden kompatibel zu Volvo Penta

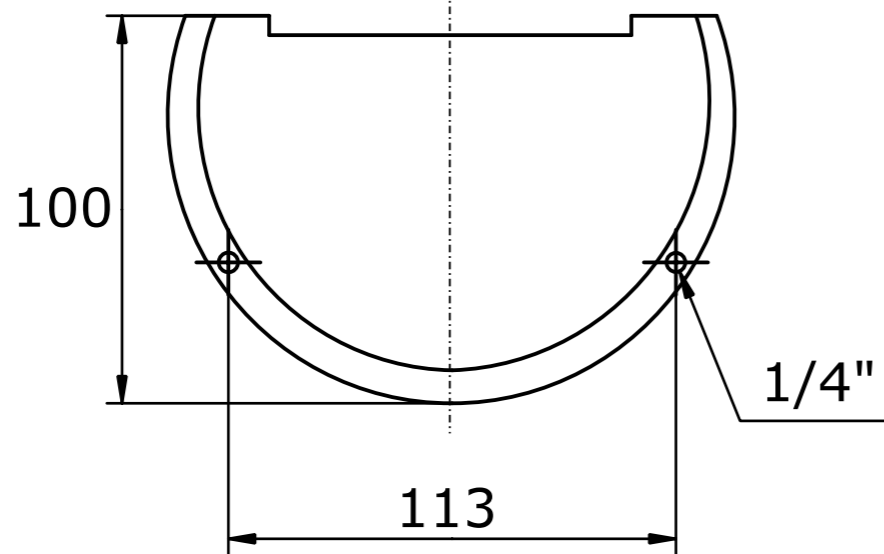

Referenznummer
3855411

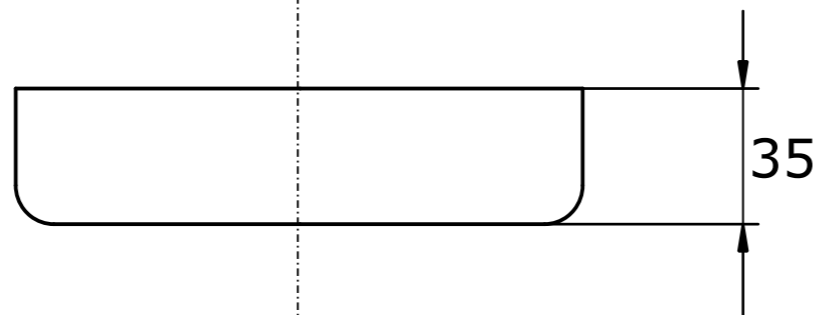
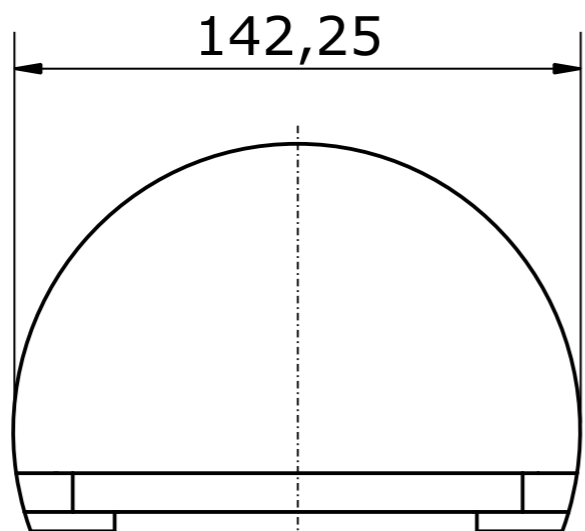
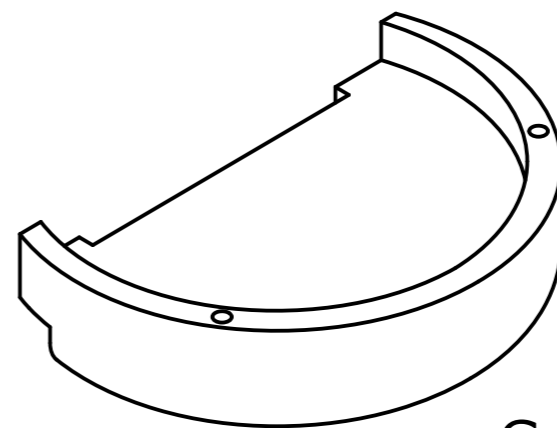

Gekippte-Ansicht

	Anoden Kategorie :	Artikelnummer:			
	Anoden kompatibel zu Volvo Penta	9236			
	Werkstoff:	Gewicht:			
	Zink	1,020kg			
ISO	Nur zur Information, unterliegt nicht dem Änderungsdienst		Maßstab: 1:1	Zst:	Änderung: Datum: