

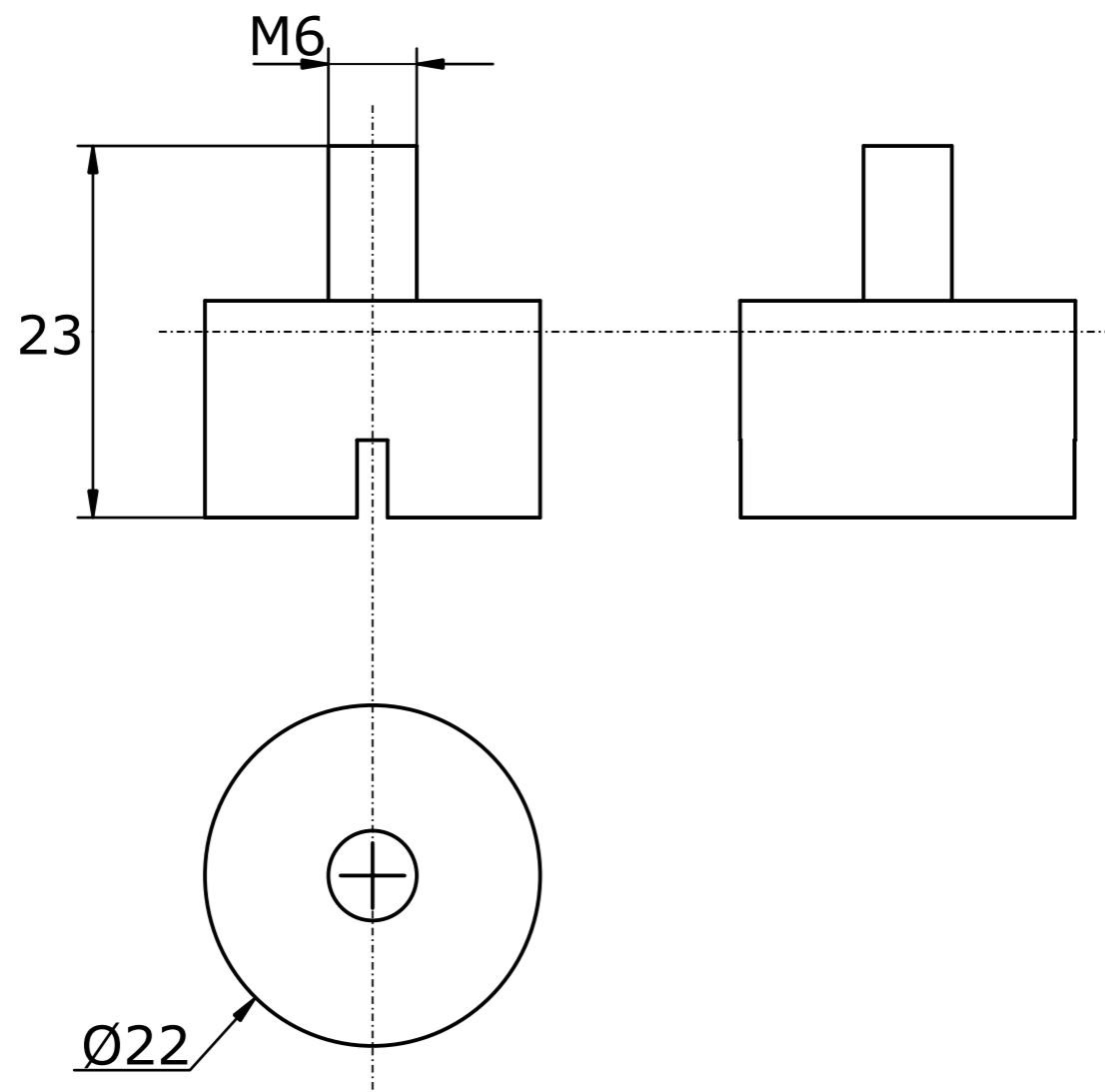

Anoden kompatibel zu Volvo Penta



Referenznummer
852019



	Anoden Kategorie :	Artikelnummer:			
	Anoden kompatibel zu Volvo Penta	9240AL			
	Werkstoff:	Gewicht:			
	AlZn5In	0,013kg			
ISO	Nur zur Information, unterliegt nicht dem Änderungsdienst		Maßstab: 1:1	Zst:	Änderung: Datum: